

Fluid control valve(2/2 way)

2KL Series (Direct-acting and normally opened)

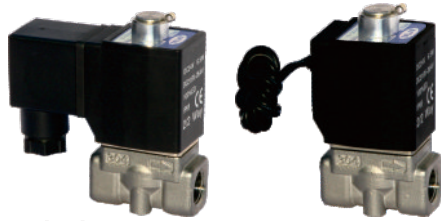

Symbol



Product feature

1. Direct acting and normally opened type 2/2 way solenoid valve. Its high sensibility allows it to change direction quickly;
2. It has wide pressure range, including standard high pressure (H) to choose from;
3. It is compact, small size and light weight. It is easy to install and dismantle.
4. The valve body is made of SUS304 . Its coil has a Heat resistance classification of Class H. The standard seal material is PTFE(Teflon) which is suitable for a variety of working medium such as water with high temperature and vapour.
5. The protection class of the coil is IP65 and there is a choice for grommet or terminal electrical entry .

Specification

Model\Item	Port size [Note1]	Orifice size (Φmm)	Cv	Valid area or section (mm ²)	Weight [Note2](g)	Max. operating pressure differentia		Proof pressure	
						MPa	psi	MPa	psi
2KLH030	-06 1/8"	2.0	0.18	3.0	305	1.5	220	3.0	450
	-08 1/4"				295				
2KL030	-06 1/8"	3.0	0.33	6.0	305	0.7	100		
	-08 1/4"				295				
2KLH050	-10 3/8"	4.0	0.55	10.0	610	1.5	220		
	-15 1/2"				600				
2KL050	-10 3/8"	5.0	0.83	15.0	610	0.7	100		
	-15 1/2"				600				

[Note1] G thread is available.

[Note2] The weight in the table is the terminal valve's weight, 2KL030 series grommet valve's weight is 10g less than terminal's. 2KL050series grommet valve's weight is 20g less than terminal's.

Specification of coil

Valve type	Coil type	Power type	Frequency (Hz)	Voltage range	Electrical entry	Power Consumption (VA/W)	Insulation	Temp. rise(°C)
2KL□030	CDA116 CLA116	AC	50	± 15%	Terminal (CDA)	15.0VA	Class H	50
			60			11.0VA		40
		DC	-	± 10%		6.5W		30
2KL□050	CDA170 CLA170	AC	50	± 15%	Grommet (CLA)	35.0VA		Class H
			60			30.0VA	60	
		DC	-	± 10%		10.5W	40	

Inner structure

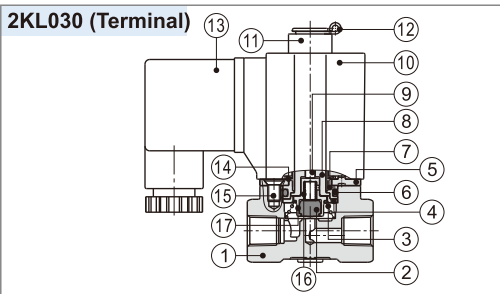

No.	Item	No.	Item	No.	Item
1	Body	7	Fixed cap	13	Connector
2	Airtight ring	8	Electromagnet	14	Spring washer
3	Spring	9	Man drill	15	Screw
4	Fixed ring	10	Coil assembly	16	Spring
5	Fixed plate	11	Position ring	17	Airtight bush
6	O-ring	12	E Clip		

Valve's specification

Acting		Direct acting				
Initial state		Normally opened				
Adaptable fluid		Steam, High temperature Water, Oil				
Viscosity limit		Under 20CST				
Ambient and fluid temperature (°C)			Oil	Water	Steam	Ambient
		Max.	150	150	183	100
		Min.	-10 [Note1]	1	-	-20

[Note1] 50CST or less.

Ordering code

Ordering code of valves

2KL H 030 08 A □ G



① Model	② Pressure condition	③ Size series	④ Port size	⑤ Voltage	⑥ Electrical entry	⑦ Thread type
2KL: 2/2 way direct-acting and normally opened	H: High pressure Blank: Standard	030: 030 Series 050: 050 Series	06: 1/8" 08: 1/4" 10: 3/8" 15: 1/2"	A: AC220V B: DC24V C: AC110V E: AC24V F: DC12V	Blank: Terminal I: Grommet	G: G

Ordering code of accessories

Ordering code of accessories is the same as 2S series valve's, Please refer to P148 for details of ordering code.

Fluid control valve(2/2 way)

2KL Series (Direct-acting and normally opened)

Flow chart

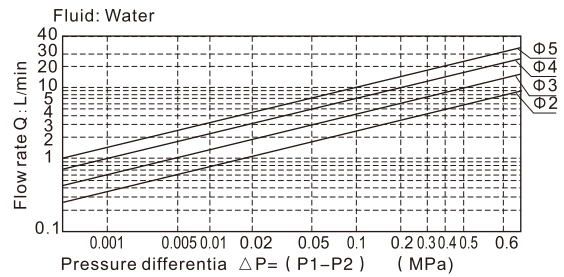
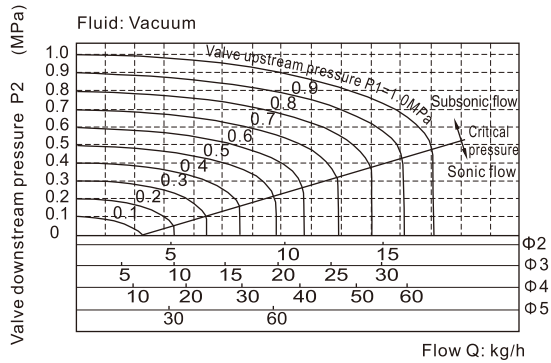

Dimensions

2KL□030(Terminal)

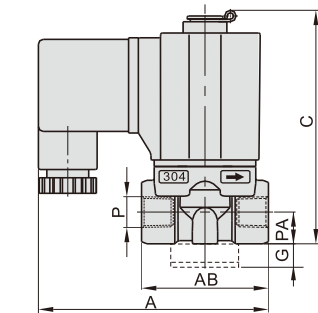
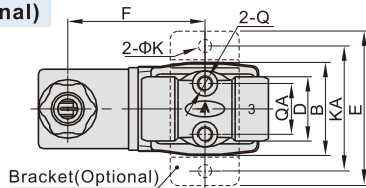

2KL□030(Grommet)

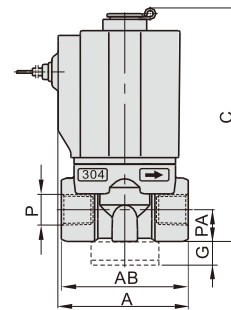
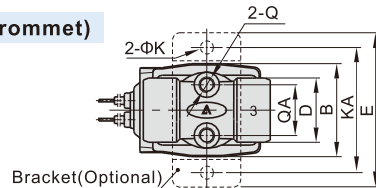

2KL□050(Terminal)

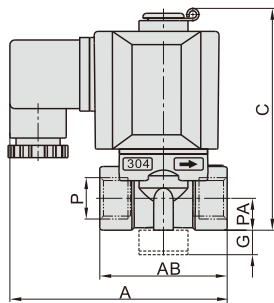
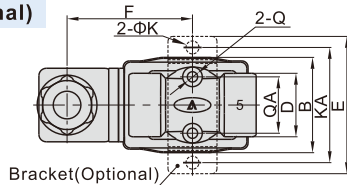

2KL□050(Grommet)

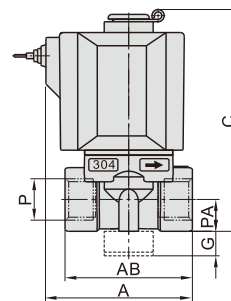
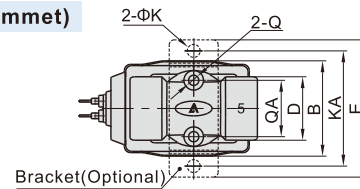

Model\Item	A	AB	B	C	D	E	F	G	K	KA	P	PA	Q	QA
2KL□030-06	72.5	40	29.5	76	20	49	43.5	10	5.3	40	1/8"	10	M5	16
2KL□030-08	72.5	40	29.5	76	20	49	43.5	10	5.3	40	1/4"	10	M5	16
2KL□050-10	89.5	52	39	92	26	56	51	10	5.3	48	3/8"	13	M5	23
2KL□050-15	89.5	52	39	92	26	56	51	10	5.3	48	1/2"	13	M5	23

Model\Item	A	AB	B	C	D	E	G	K	KA	P	PA	Q	QA
2KL□030-06	41	40	29.5	76	20	49	10	5.3	40	1/8"	10	M5	16
2KL□030-08	41	40	29.5	76	20	49	10	5.3	40	1/4"	10	M5	16
2KL□050-10	60	52	39	92	26	56	10	5.3	48	3/8"	13	M5	23
2KL□050-15	60	52	39	92	26	56	10	5.3	48	1/2"	13	M5	23